

**RKMV / RSMV** 3, 4, and 8 Pole

Pico (M8) single ended cordset, female and male, straight, 3- and 4-pole with self locking thread, joint and molded 22 AWG, halogen free Lumflex black PUR cable, IEC color code, IP67/69K and NEMA 6P rated. 8-Pole version in female only.

**RKMWV / RSMWV** 3 and 4 Pole

Pico (M8) single ended cordset, female and male, right angle, 3- and 4-pole with self locking thread, joint and mold 22 AWG, halogen free Lumflex black PUR cable, IEC Color Code, IP67/69K and NEMA 6P rated.

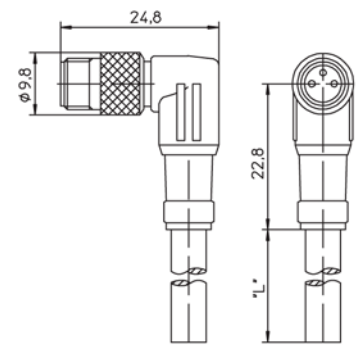
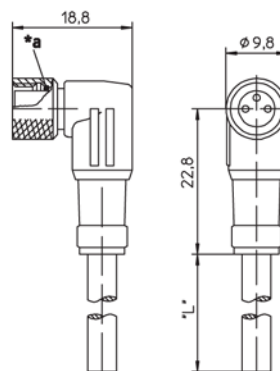
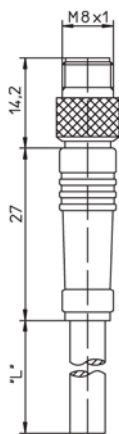
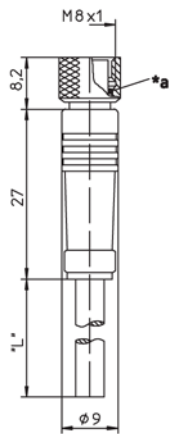

\*a O-Ring  
O-ring

**Pin Assignment**

**Pico (M8)  
3-Poles**

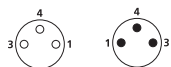

- 1 = brown
- 3 = blue
- 4 = black

**4-Poles**

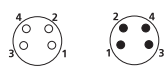

- 1 = brown
- 2 = white
- 3 = blue
- 4 = black

**8-Poles**



- 1 = white
- 2 = brown
- 3 = green
- 4 = yellow
- 5 = grey
- 6 = pink
- 7 = blue
- 8 = red

**PUR** IEC Color Code  
UL Type: AWM 21198 or AWM 20549  
Gauge: 22 and 26



**Technical Data**  
Degree of protection IP67/ IP69K  
Operating temperature range -25°C (-13°F) / +80°C (+176°F)

**Mechanical**  
Molded body TPU, translucent  
Insert TPU, self-extinguishing  
Contact Brass, pre-nickeled and 0.8 microns gold-plated  
  
Coupling nut Brass, nickel-plated

**Electrical**  
Contact resistance  $\leq 5m\Omega$   
  
Voltage rating 3 poles: 63 V  
4-8 poles: 36 V  
  
Current rating 3-4 poles: 4 A  
8 poles: 1 A

Cable Specifications				
Cable Number	Outer Jacket	Conductor Size	Color	Outside Diameter
224	PUR, halogen free	22 AWG	Black	.169" (4.3 mm)
225	PUR, halogen free	22 AWG	Black	.185" (4.7 mm)
354	PUR, halogen free	22 AWG	Black	.197" (5.0 mm)

Mating Receptacles			
Part Number	Receptacle	Part Number	Receptacle
RKMV 3-224/...M RKMVV 3-224/...M	RSMF 3/0.5M RSMHL 3/S 5,5	RSMV 3-224/...M	RKMF 3/0.5 M RKMHHL 3/S 5,5
RKMV 4-225/...M RKMVV 4-225/...M	RSMF 4/0.5M RSMHL 4/S 5,5	RSMV 4-225/...M	RKMF 4/0.5 M RKMHHL 4/S 5,5
RKMV 8-354/...M	RSMF 8/0.5M		

Part Number				Poles	
Female Straight	Male Straight	Female Right Angle	Male Right Angle		
RKMV 3-224/...M	RSMV 3-224/...M	RKMVV 3-224/...M	RSMVV 3-224/...M	3	
RKMV 4-225/...M	RSMV 4-225/...M	RKMVV 4-225/...M	RSMVV 4-225/...M	4	
RKMV 8-354/...M				8	

Standard cable lengths: 2 M / 5 M / 10 M  
Other cable lengths or cable specifications on request.